



## IN.VOLA

SUSPENDED LUMINAIRE

The decorative suspended luminaire IN.VOLA attracts attention to itself already from far off and supports high-quality shop design. Two glass shade shapes, a spherical and a conical segment, can be chosen from. Besides the decorative lighting effect, an optical light directing system is selectable for systematic product illumination.



### Attractive design

Eye-catching design for a high-quality company appearance.



### Various shapes and colours

Two shade shapes spherical segment and conical segment available in several colours



### Equipment with many variants

Six white light colours and luminous flux packages of up to 2,500 lumens for all store requirements



### Intelligent light

Smart lighting management optionally with control line or wireless

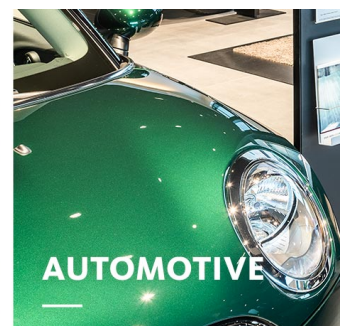
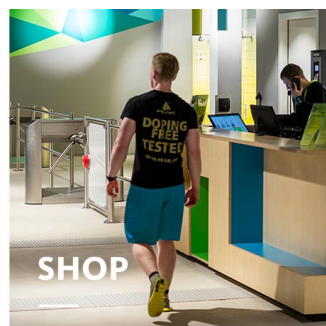
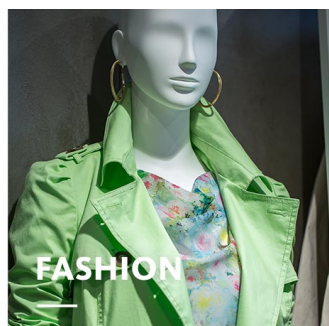
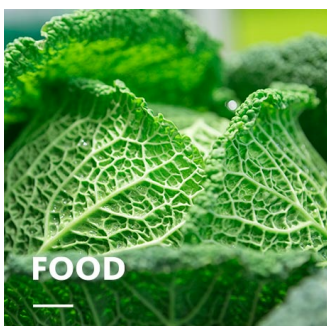

# IN.VOLA

# oktalite

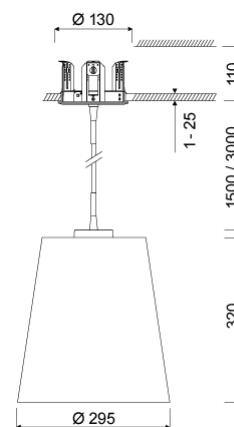
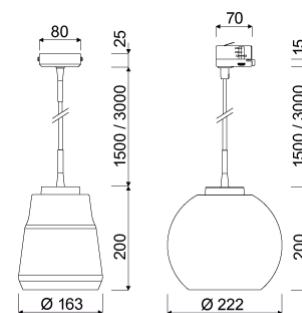

[www.oktalite.com/invola-p](http://www.oktalite.com/invola-p)

Type of luminaire	suspended luminaire
Application areas	Decorative lighting
Pan/tilt range	fixed
Mounting	3P Power Track, recessed (Ø 130mm), Surface mounted
Ceiling thickness	1 - 25 mm
Lighting technology	E27
Lamp power	max. 60 W
Luminaire colour	RAL 9005 jet black
	Special colours on request
Surface	structure powder-coated
Shade	Glass, textile, different colors
Suspension length	1500mm, 3000mm
Nominal voltage	220 - 240 V, 50/60Hz



Weight: Approx. 1.6 kg

Components

-  Luminaire housing
-  Shade
-  Lamp

Test seal



Technical details as well as weight specifications and measurements have been prepared with care. Errors excepted. All dimensions in mm · LED service life data: L80/B10 at ambient temperature (ta) 25°C. Rated lamp service life 50,000h. Luminous flux and efficiency specifications are subject to a tolerance of +/- 10%. Min CRI Ra: >80 / >90· Product images are used as an example and may differ from the original · We reserve the right to make changes, insofar as they serve progress. The Single Lighting Regulation (SLR) documentation can be found in our download area. Oktalite Lichttechnik GmbH · Mathias-Brüggen-Str. 73 · 50829 Cologne · T 49 221 59767-0 · F 49 221 59767-40 · mail@oktalite.com · www.oktalite.com · 2022-11-29



Luminaire housing - E27

**IN.VOLA**

**oktalite**

Lighting technology	Mounting	Mount Color	Suspension length	Order number		
				white	silver	black
E27	3P Power Track	black	1500mm			10150382
E27	3P Power Track	black	3000mm			10150383
E27	Surface mounted H3	RAL 9016 traffic white	1500mm			10157731
E27	Surface mounted H3	RAL 9016 traffic white	3000mm			10157732
E27	Surface mounted H3	RAL 9005 jet black	1500mm			10150384
E27	Surface mounted H3	RAL 9005 jet black	3000mm			10150385
E27	recessed H19 (Ø 130mm)	RAL 9016 traffic white	1500mm			10247863
E27	recessed H19 (Ø 130mm)	RAL 9016 traffic white	3000mm			10247864
E27	recessed H19 (Ø 130mm)	RAL 9005 jet black	1500mm			10247861
E27	recessed H19 (Ø 130mm)	RAL 9005 jet black	3000mm			10247862

Technical details as well as weight specifications and measurements have been prepared with care. Errors excepted. All dimensions in mm · LED service life data: L80/B10 at ambient temperature (ta) 25°C. Rated lamp service life 50,000h. Luminous flux and efficiency specifications are subject to a tolerance of +/- 10%. Min CRI Ra: >80 / >90 · Product images are used as an example and may differ from the original · We reserve the right to make changes, insofar as they serve progress. The Single Lighting Regulation (SLR) documentation can be found in our download area. Oktalite Lichttechnik GmbH · Mathias-Brüggen-Str. 73 · 50829 Cologne · T 49 221 59767-0 · F 49 221 59767-40 · mail@oktalite.com · www.oktalite.com · 2022-11-29

# Shade - IN.VOLA

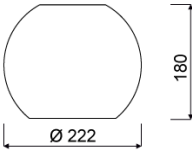
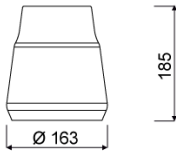
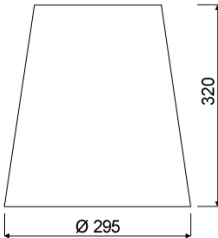
Shade	Material	Colour of lamp shade	Shade surface	translucence	profile	Order number
	Glass	white	matt	translucent	Ball	10150388
	Glass	white	matt	translucent	conical	10150393
	Glass	Smoke Glass Beige Gray	glossy	transparent	Ball	10150390
	Glass	Smoke Glass Beige Gray	glossy	transparent	conical	10150395
	textile	White - C10	Matt - Leaves	translucent	conical	10231391
	textile	White - C10	Matt - Clean	translucent	conical	10231390
	textile	White - C10	Matt - Tulip	translucent	conical	10231392

Technical details as well as weight specifications and measurements have been prepared with care. Errors excepted. All dimensions in mm · LED service life data: L80/B10 at ambient temperature (ta) 25°C. Rated lamp service life 50,000h. Luminous flux and efficiency specifications are subject to a tolerance of +/- 10%. Min CRI Ra: >80 / >90· Product images are used as an example and may differ from the original · We reserve the right to make changes, insofar as they serve progress. The Single Lighting Regulation (SLR) documentation can be found in our download area. Oktalite Lichttechnik GmbH · Mathias-Brüggen-Str. 73 · 50829 Cologne · T 49 221 59767-0 · F 49 221 59767-40 · mail@oktalite.com · www.oktalite.com · 2022-11-29



Lamp - E27

# E27

# oktalite

LED Luminous Flux Class	Light colour	Lamp power	CRI R <sub>a</sub>	Manufacturer	Lamp surface	Dimmable	Order number
470 lm	2700 K	4 W	82	Osram	clear filament	non-dimmable	10155606
806 lm	2700 K	7,2 W	82	Osram	matt	non-dimmable	10155607

Technical details as well as weight specifications and measurements have been prepared with care. Errors excepted. All dimensions in mm · LED service life data: L80/B10 at ambient temperature (ta) 25°C. Rated lamp service life 50,000h. Luminous flux and efficiency specifications are subject to a tolerance of +/- 10%. Min CRI Ra: >80 / >90 · Product images are used as an example and may differ from the original · We reserve the right to make changes, insofar as they serve progress. The Single Lighting Regulation (SLR) documentation can be found in our download area. Oktalite Lichttechnik GmbH · Mathias-Brüggen-Str. 73 · 50829 Cologne · T 49 221 59767-0 · F 49 221 59767-40 · mail@oktalite.com · www.oktalite.com · 2022-11-29